

AF
Alu-Fab



comar
ARCHITECTURAL ALUMINIUM SYSTEMS

Uniclass	EPIC
L413:P43	D13:X421
Cl/SfB	
(31.4)	Xh4

comar5Pi

Energy Efficient Aluminium Window System

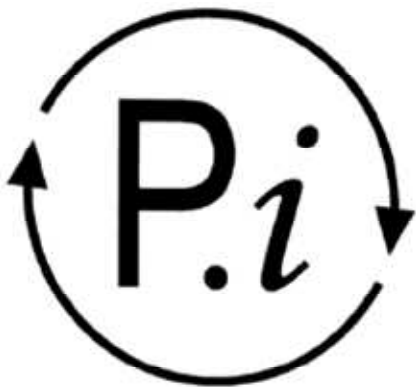
A thermally broken window suite in configurations of: casement, tilt and turn, vertical or horizontal pivot, sliding and top swing reversible.



complementing architecture

Design

Solution

Perform

Deliver

On-time

Sustainable

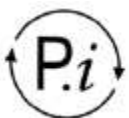

BSI: ISO 14001



BSI: ISO 9001



comar

Comar Architectural Aluminium Systems is the largest British, privately owned aluminium systems company in Europe.

Comar designs, extrudes and distributes over 700 integrated profiles to a Nationwide approved fabricator network for use in aluminium ground floor treatment, window, door and curtain walling applications.

Comar has built its reputation on delivery. Over £5M of mill, standard white polyester powder coating, silver and bronze anodised profiles are kept in stock. This means that 99% of orders are fulfilled by our customers next weekly delivery. Single and dual colour polyester powder coating can be delivered in 15 working days. For architects and specifiers, a Nationwide team of architectural advisors provide project-by-project advice on design, building regulations, U-value and wind loading calculations as well as NBS specifications, budget pricing and approved fabricators. This service to specifiers ensures that projects run smoothly from concept to installation.

Comar Architectural Aluminium Systems is an ISO 9001 registered company. Comar is a member of the Council for Aluminium in Building, (C.A.B) and is a Technical Committee member. Comar provides CPD seminars to architects and designers through the RIBA CPD network and offers CWCT training courses and seminars through its own Training Centre at Mitcham in Surrey.

Comar is a member of the C.W.C.T.

Membership with these Associations ensures that customers are kept up-to-date with the very latest in building technology and regulations.

Comar Designed for Performance, Backed by Delivery.



design

Comar 5Pi Window System

The Comar 5Pi aluminium window range is designed to take into account the needs of users of aluminium window systems, now and in the future.

The users are the designing specifiers and architects who care about delivering an aesthetic solution with long term performance, the fabricator who wants systems that are economical, easy to fabricate and delivered on time and, finally, the end user who wants a building that will stand the test of time and provide energy efficiency.

Comar 5Pi has three high performing suites, ensuring that even the most demanding project can be completed from a single source.

The Comar 5Pi range includes all window configurations, such as: side-hung, bottom-hung, top-hung, horizontal and vertical pivot, tilt and turn, top-swing reversible and sliding windows. Comar 5Pi integrates with all Comar products to provide opening vents coupled to doors, window walling, curtain walling and ground floor treatment, as well as coupled together to provide ribbon windows.

Comar 5Pi offers low U-values and is available in 3 profile widths: 55mm, 60mm and 75mm with glazing options from 22mm to 45mm. The 55mm, 60mm, 75mm system, Comar 5Pi, is a polyamide system that provides exceptional thermal efficiency for applications where accurate U-value trade-offs are required. Comar 5Pi answers the demands of the latest building regulations by providing enhanced thermal performance, reducing heat loss and maintaining temperatures for longer. This directly impacts on the clients long term use of the building, reducing energy bills. Comar 5Pi also provides a realm of design option with its dual colour option: the internal face and external faces of the profiles can be polyester powder coated or anodised in a multitude of colours and finishes.

Comar 5Pi can incorporate through frame or glazed-in ventilators from the Comar-Duco range.

Comar 5Pi offers outstanding weather performance, exceeding the requirements of the very latest weather tightness tests: BS 6375, BS ENs 1026, 1027 & 12211.

Thermal Performance

Comar 5Pi offers exceptionally low U-values. Supporting this thermally broken suite is Comar's Technical Department who offer advice to architects, specifiers and fabricators on U-value calculations, wind loading and integration. This service is offered on a project-by-project basis.



Genesis

To our Nationwide network of approved fabricators, Comar supplies Genesis estimating software. Genesis is a powerful estimating tool; it provides fast, accurate pricing from plans and tenders for the entire Comar product range.

Genesis includes the facility to provide section through details which can be exported to CAD so Comar approved fabricators can add detail to design drawings.

All approved fabricators are trained in Genesis, ensuring Comar approved fabricators provide accurate budget pricing and tender returns.

Research and Development

Comar 5Pi has been continuously developed to ensure it can be used to complete the most demanding façade. New profiles are regularly introduced. If your project requires new extrusions, Comar's Technical Department will discuss individual projects and develop new profiles to achieve the design brief.

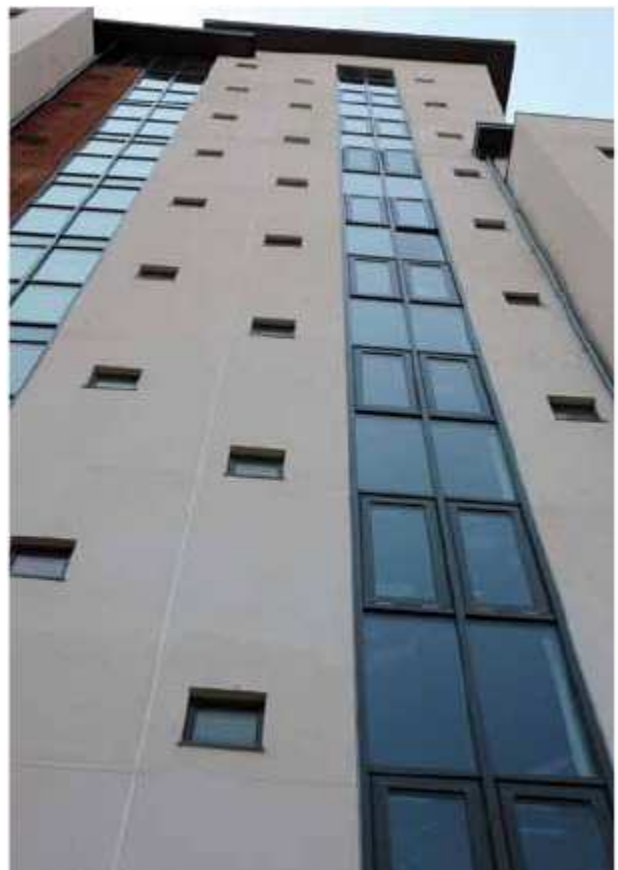

design

Comar 5P.i 60mm Windows

Description

Comar 5P.i are thermally efficient polyamide insulated aluminium windows that offer outstanding weather performance and low U-values. Profiles are extruded separately then rolled together with a 22mm polyamide strip offering a dual colour option.

Types

Side, bottom and top hung, horizontal and vertical pivot, tilt and turn, top-swing reversible and vertical and horizontal sliding windows.

Comar 5P.i ECO Windows

Description

Comar 5P.i ECO are thermally efficient casement polyamide insulated windows.

Types

Side and top-hung windows.

Combinations

The Comar 5P.i range can be installed directly into Comar 6 curtain walling and Comar 2 window walling and create side and fan lights for Comar 7 entrances.



solution

Specification

Comar Architectural Aluminium Systems have a Nationwide team of architectural advisors who specialise in providing architects and specifiers with project support, calculations and NBS specifications.

The relevant NBS clauses are:

- H11 Curtain Walling
- L10 Windows/Rooflights/Screens
- L20 Doors/Shutters/Hatches

Nationwide Approved Fabricator Network

Once Comar 5Pi has been specified, a Nationwide network of approved fabricators ensures the successful completion of projects.

Your Comar architectural advisor can provide fabricators who specialise in commercial, new, refurbishment or public building work.

Calculation

Calculations, such as wind-loading, U-values, size and weight limitations for projects, can be obtained from Comar's Technical Department.



Finishes

Comar 5Pi finishes are available in all RAL, Syntha Pulvin and BS colours. Aluminium profiles are finished to the following specifications: silver, bronze and black anodising AA 25 to BS EN 12373-1: 2001 or BS 3987. Liquid organic coating to BS 4842: 1984. Polyester powder coating to BS 6496: 1984.

Weather Performance

On test, Comar 5Pi windows exceeded the requirements of BS6375 Part 1:

2400Pa	Special. Resistance to Wind Load
600Pa	Water-tightness
600Pa	Air-tightness



solution

Thermal Performance Comar

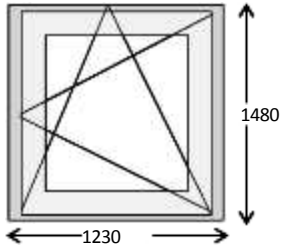

	(1230 x 1480)	
<i>Glass Centre Pane</i>	0.5	1.0
Comar 5Pi Tilt and Turn	1.16	1.57

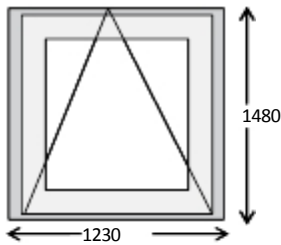

	(1230 x 1480)	
<i>Glass Centre Pane</i>	0.5	1.0
Comar 5Pi Casement	1.33	1.72
Comar 5Pi Eco	1.31	1.73

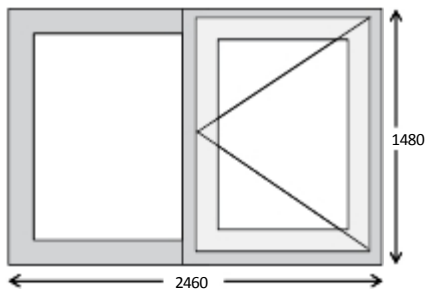

	(2460 x 1480)	
<i>Glass Centre Pane</i>	0.5	1.0
Comar 5Pi Casement	1.37	1.78

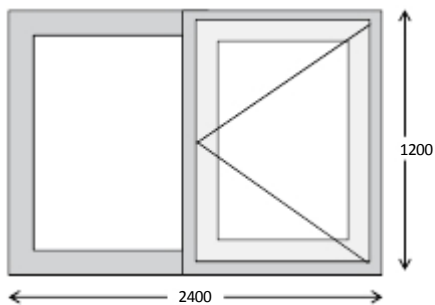

	(2400 x 1200)	
<i>Glass Centre Pane</i>	0.5	1.0
Comar 5Pi Eco	1.28	1.71

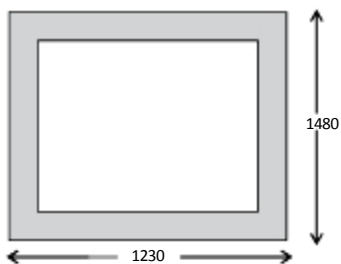

	(1230 x 1480)	
<i>Glass Centre Pane</i>	0.5	1.0
Comar 5Pi Fixed Light	0.96	1.42

perform

Comar 5P.i ECO, 55mm & 75mm, Internally & Externally

Window Type	Maximum Width	Maximum Height	Maximum Weight
Side Projected	1000mm	1300mm	40kg*
Top Projected	1200mm	1200mm	32kg*

Comar 5P.i 60mm

Internally Glazed

Window Type	Maximum Width	Maximum Height	Maximum Weight
Tilt/Turn	1100mm	1600mm	90kg*
Horizontal Pivot	1350mm	1350mm	180kg*
Vertical Pivot	1350mm	1350mm	120kg*
Side Projected	1000mm	1500mm	24kg*
Top Projected	1000mm	1600mm	100kg*
Top Swing	1000mm	1600mm	60kg*
Top Hung	1100mm	1500mm	70kg*
Side Hung	1100mm	1500mm	35kg*



perform

Comar 5P.i 60mm

Externally Glazed

Window Type	Maximum Width	Maximum Height	Maximum Weight
Side Projected	1000mm	900mm	24kg*
Top Projected	1000mm	900mm	35kg*

Comar 5P.i Horizontal Sliding Window

Window Type	Maximum Width	Maximum Height	Maximum Weight
Horizontal Sliding Window	1500mm	1800mm	180kg
Vertical Comar 5P.i VSW	1500mm	2800mm	50kg Per Sash

**Maximum weights are determined by manufacturer's hardware options.*

The above limitations are dependent on the project application. Larger or smaller sizes may be achieved.

Please contact Comar's Technical Department for project-by-project advice.

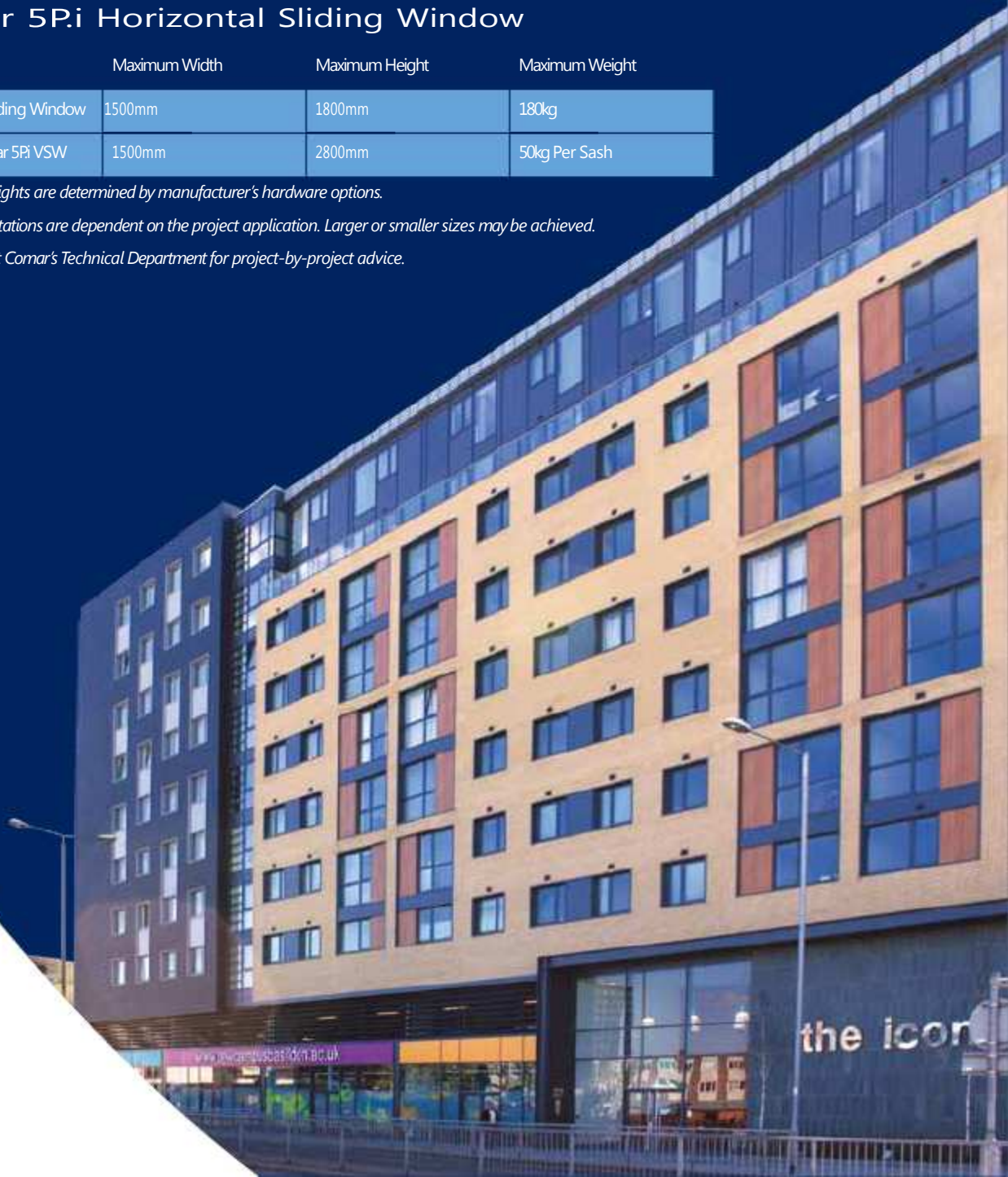

deliver

Hardware, Glazing & Gaskets

Hardware

Comar 5Pi utilises a range of hardware such as handles, locks, friction stays and restrictors. Apart from unique components, such as concealed butt hinges, all Comar window systems utilise hardware selected from standard catalogue items for Euro-groove fitting.

Glazing

Generally, all glazing shall comply with the requirements of BS 6375 and BS 6262:1982, British Standard Code of practice for Glazing in Buildings.

Glazing beads and gaskets allow for an exceptional range of glazing thickness from 4mm to 45mm, dependent on window system specified (see below). For commercial applications, glazing beads are fitted internally. Drainage of glazing and opening lights is an important

aspect of design. Profiles have drainage slots in the glazed recess and rebated areas to ensure ventilation and drainage of the rebates as well as providing a water barrier.

Where specified, hermetically sealed double glazed units shall comply with the requirement of BS 5713 : 1979. The specification of hermetically sealed double glazed units shall be as stated in the works section.

Glazing Options	Minimum Glazing	Maximum Glazing
Comar 5Pi 60mm	22mm	45mm
Comar 5Pi ECO	24mm	32mm

Gaskets

Glazing materials are high performance pre-formed non-structural gaskets complying with the requirements of BS 4255, Part 2.

Security

Comar 5Pi has been designed to conform to the relevant industry standards, PAS24:2012 and recommends all third party hardware should hold a recognised PAS24:2012 certificate.

Materials

Extruded aluminium profiles are of aluminium alloy 6063 T5, T6 to BS EN 12020 and BS EN 755-1 : 1997. Comar 5Pi has a thermal barrier 20mm polyamide strip. Comar 5Pi and Comar 5It are insulated with a 6mm 'poured-and-cut' thermal barrier. Gaskets are extruded from E.P.D.M. rubber.



deliver



Construction

Fixed light frames are constructed with mitre joints with a spring loaded or inserted cleat which is either crimped or tightened with eccentric cam.

Multi-light transoms and mullions are secured with No.8 screws into integral ports or with cleats, with the addition of dowel pins.

For larger vent sizes an optional adjustable cleat can be inserted which provides increased strength.

Comar 5P.i Casement

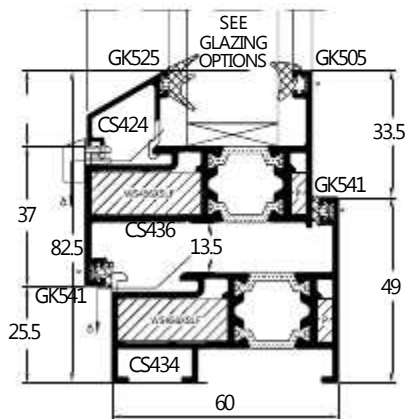

General arrangement showing externally glazed Comar 5P.i casement window, 60mm System.

Comar 5P.i Security Casement

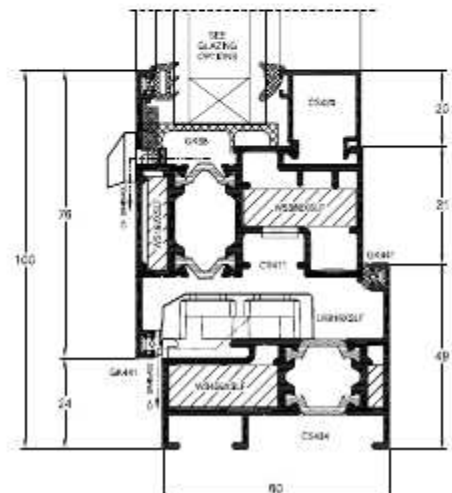

General arrangement showing security rated internally glazed Comar 5P.i casement window.

on-time

Comar 5Pi Window System

General arrangement showing Comar 5Pi windows integrating into Comar 2 window walling to provide opening lights to a façade.

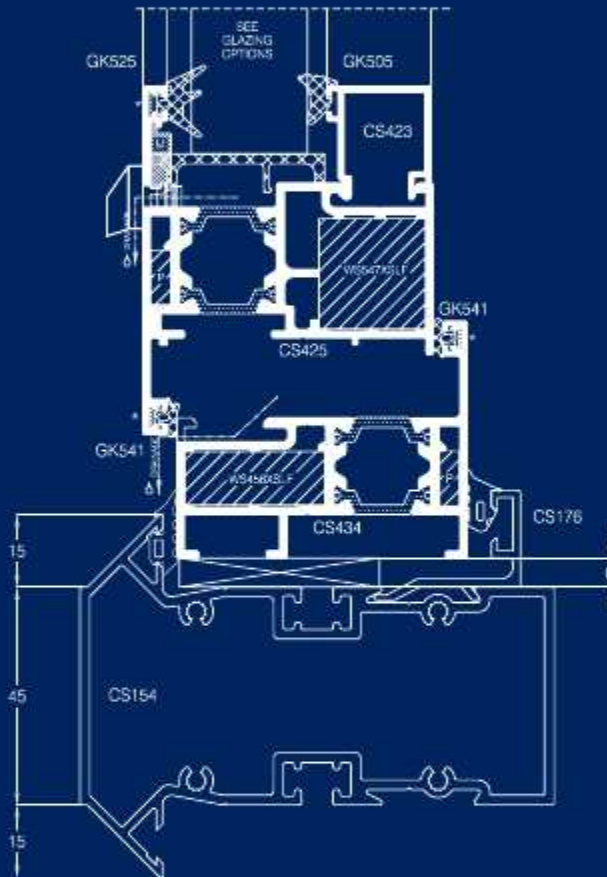

Comar 5Pi ECO 55mm Internally Beaded

General arrangement showing Comar 5Pi ECO 55mm, window outer frame, open out sill detail, internally beaded vent with transfer profile.

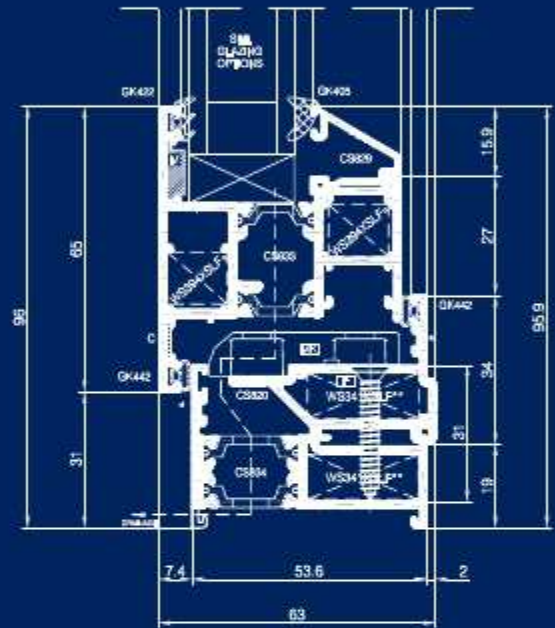

Curtain Wall Insert

General arrangement showing Comar 5Pi windows integrating into Comar 6 curtain walling to provide opening lights to a curtain wall façade.

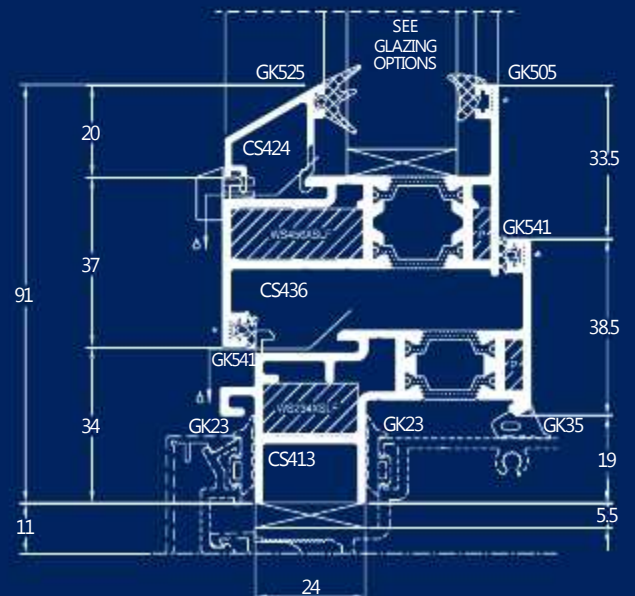

on-time

Comar 5P.i Window Vent Corner

Exploded view of heavy duty Comar 5P.i vent corner. The WS416XSFL Alignment Square ensures that a high quality finish can be achieved in a mitred corner.

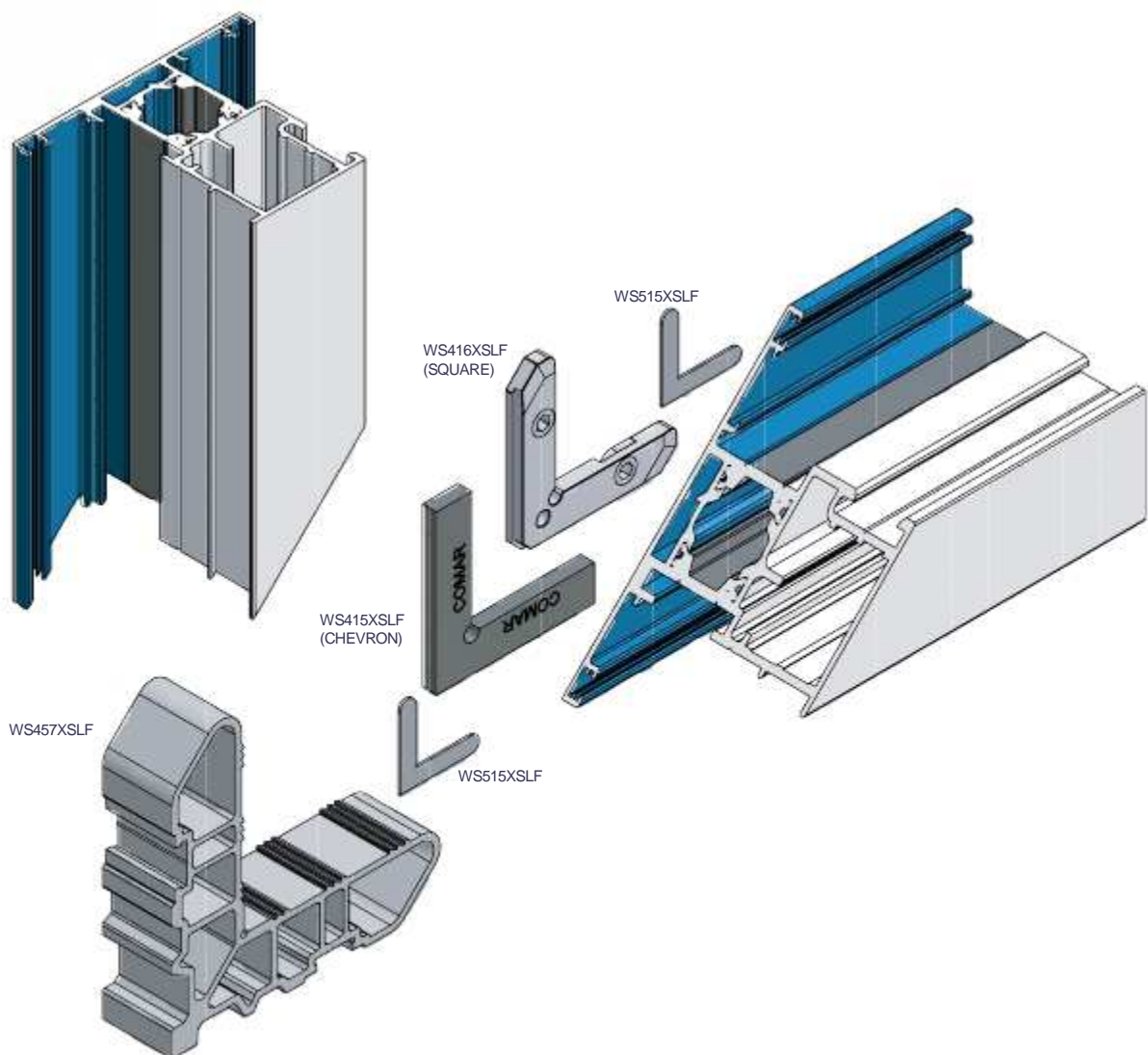

sustainable

Sustainability

Today's world calls for us all to be more conscious of our environment. In 1998 the world recognized this by signing the Kyoto Agreement. The Kyoto Agreement directly affected the construction industry by demanding that buildings become more thermally efficient. With these demands longevity, thermal efficiency, sustainability and recyclability are now critical factors in construction.

Why Aluminium...

Aluminium provides a unique solution for today's construction needs. Aluminium is light, strong, durable and flexible which provides tremendous potential for achieving even the most demanding design brief. Two-thirds of the energy required to extract aluminium is supplied by environmentally friendly, hydroelectric power. Couple this with the recyclability of aluminium and aluminium is the ideal choice for windows, doors and facades.

Longevity

Unlike some alternative building materials, aluminium offers an almost unlimited life expectancy. A notable example of this is the Statue of Eros in London's Piccadilly Circus, which has only just been cleaned and renovated, and The Empire State Building, the latter being the first building to use anodised aluminium. Aluminium does not age like other organic materials and needs no protection from ultra-violet light. Aluminium can be polyester powder coated or anodised to a variety of colours, which enhances the materials natural durability. Comar's powder coaters guarantee their finishes for 25 years and anodisers for 30 years.

Sustainability...

The recycling process now produces high quality aluminium, which is very cost effective and can be carried out on an indefinite number of occasions without impairing the quality in any way. It is a very durable material and has very low maintenance requirements, therefore reducing the whole-life cost. It is long lasting and can withstand the ravages of the most extreme conditions. Aluminium is an excellent material to use in marine and coastal environments, as the effect of sodium chloride is minimal.

Sustainability concerns are alleviated by the knowledge that we have at least 300 years of known reserves of the raw material, Bauxite, and this does not allow for the fact that 70% of all aluminium used is recycled at the end of its product life.

Thus, with ever increasing proportion of re-cycled material in use, aluminium can be accurately described as the ultimate sustainable material.

Recycling Check List

"The recyclability of aluminium – one of its unique properties along with strength, durability and corrosion resistance – has led to its increased use in construction over recent years. Used aluminium is valuable and is easily and endlessly recycled without quality loss. The material is very rarely 'lost' entirely because of this."

Important issues to note are:

- The quality of aluminium is not impaired by endlessly recycling
- Re-smelting aluminium saves up to 95% of the energy needed to produce the primary product
- It is the most cost-effective material to recycle
- The overall market for used aluminium is steadily growing, so the more aluminium there is in a product, the more chance it has of being re-cycled
- The recycling rate of used aluminium products in building is over 80% (over 95% in transportation and 30% in packaging)
- 30% of the 1.9 million tonnes of aluminium used in Europe in 1997 came from recycling

Source: Council for Aluminium Building & The European Aluminium Association.

Standards

BS EN ISO 14001:	Comar is an ISO 14001 registered firm, certificate number: EMS 555373
BS EN ISO 9001:	Comar is an ISO 9001 registered firm, certificate number: BSI: FM553615
BS EN 755:	Aluminium alloy extrusion
BS EN 485:	Aluminium alloy sheet
BS EN515:	Aluminium and aluminium alloys – Wrought products temper designations
BS 4255 -1:	Gaskets
BS EN573-3:	Aluminium and aluminium alloys – Chemical composition – Wrought products – part 3
BS EN12020 -1:	Aluminium and aluminium alloys – Extruded precision profiles – part 1: inspection and delivery
BS EN12020 - 2:	Aluminium and aluminium alloys – Extruded precision profiles – part 2: tolerances on dimension and form.
BS EN1991-1- 4:	Eurocode/Actions on structures. General actions. Wind actions.
BS 4873:	Specification for aluminium alloy windows.
BS 6375 -1:	Classification for weather tightness.
BS 368:	Method of testing windows
BS 5713:	Hermetically sealed flat double glazed units
BS 6262:	Code of practice for glazing of buildings
BS 6496:	Specification for powder organic coatings to aluminium alloys for external architectural purposes
EN ISO 7599:	Method of specifying anodic oxidation coatings on aluminium and its alloy
BS 3987: 1991	Specification for anodic oxide coatings for external architectural purposes
BS 6399 - 2:	Code of practice for wind loads
C.W.C.T.	(Centre for Window & Cladding Technology)

Kitemark BSi Licences:

KM 578159 - BS 4873	Systems Supplier Aluminium alloy windows
KM 578160 - BS 4873/PAS24	Enhanced security performance of windows for domestic applications
KM 590092 - PAS 23-1 & PAS 24-1	System Supplier - General and Enhanced Security Performance Requirements for Door Assemblies
KM 593756 - BS 4873/PAS24	Door System Supplier

Secured by Design Licence Holder